

Body Type

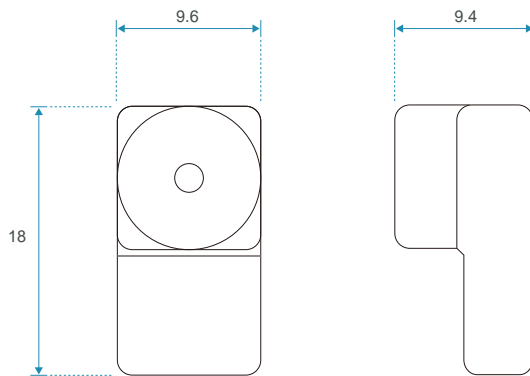

Feature

- High Sensitivity!
- High Performance.
- ultra mini invisible camera
- 550 TV lines
- Compact size

Specification

unit : mm (±0.5)

Model	MO-S9700U	MO-S9500U
Video system	EIA / CCIR	NTSC / PAL
Number of effective pixels	648 x 488 (EIA/NTSC & CCIR/PAL)	
Image sensor	1/4" CCIQIII B/W Camera	1/4" CCIQIII color Camera
Resolution(TV Lines)	550 TV Lines	480 TV Lines
S/N Ratio	47.0 [dB]	
Max Dynamic Range	63.3 [dB]	
Sensor scan mode	progressive scan	
Minimum illumination	0.006 Lux/ F1.2	0.02 Lux/ F1.2
Frame Rate	60 field/sec (EIA/NTSC) , 50 field/sec CVBS (CCIR/PAL)	
Sensitivity	8.2 [V/Lux.sec]	
Horizontal sync frequency	EIA -15.734kHz , CCIR - 15.625kHz	
Vertical sync frequency	EIA - 60Hz , CCIR - 50Hz	
Camera consumption	0.45	
Video output	1Vp-p , 75ohm composite	
Built-in Lens	4.5mm F2.8	
LED	IR LED 940 nm X 16	
Storage temperature	-30 to 60 Degree C	
Working temperature	-10 to 45 Degree C	
Power source	Camera input: DC 5~12V	
Power current	80 mA(max)-DC12V	
Dimension (mm)	9.6 x 18 x 9.4 mm	











MO-S9700



MO-S8700

Order information

MODEL	IMAGE SENSOR	LED	NOTE
MO-S9700U	1/4" CCIQ III B/W Camera	IR 940 nm x 16	F image  IMAGE TOP
MO-S9700D			F image  IMAGE TOP
MO-S9500U	1/4" CCIQ III COLOR Camera		F image  IMAGE TOP
MO-S9500D			F image  IMAGE TOP



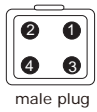

MODEL	IMAGE SENSOR	LED	NOTE
MO-S8700U	1/4" CCIQ III B/W Camera	IR 850 nm x 16	F image  IMAGE TOP
MO-S8700D			F image  IMAGE TOP
MO-S8500U	1/4" CCIQ III COLOR Camera		F image  IMAGE TOP
MO-S8500D			F image  IMAGE TOP



- 1. VIDEO
- 2. DC 5~12V
- 3. GND
- 4. AUDIO (Optional)



LED & camera power switch

Type 1	CAMERA : OFF LED : OFF	Type 2	CAMERA : OFF LED : ON	Type 3	CAMERA : ON LED : OFF	Type 3	CAMERA : ON LED : ON
							

Note:
LED x 16

