

**Feature**

- 1080p High resolution borescope inspection
- (D)6 x (L)10 mm short camera head!
- Steel rigid camera length!
- UVC signal output
- LED brightness control
- Camera setting can be adjusted by software!

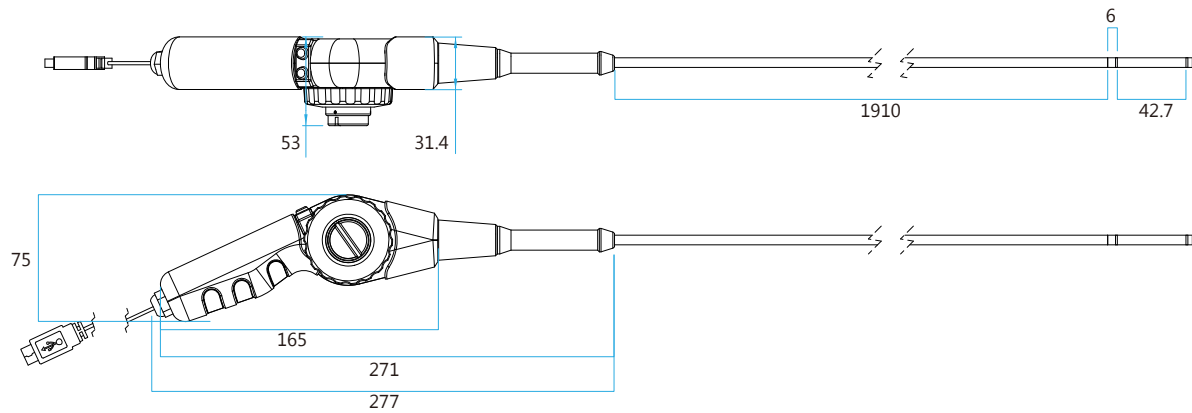

10-VD508-311-2W-77

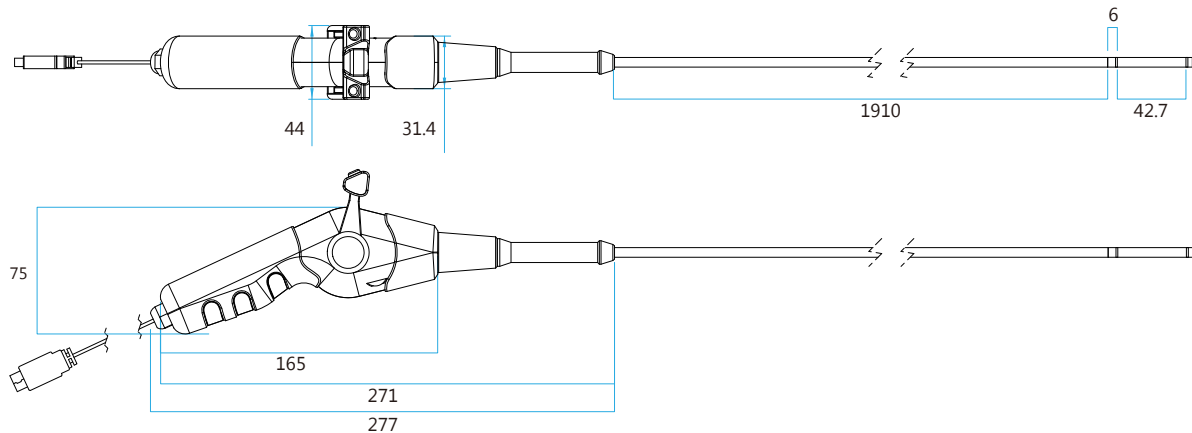

10-VD518-311-2W-77

## Specification

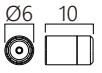
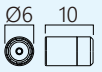
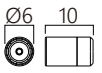
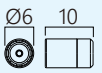
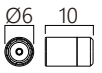
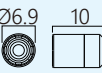
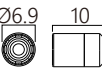
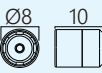
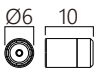
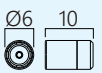
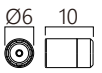
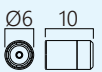
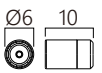
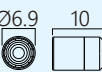
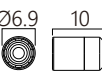
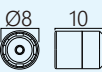
Resolution		1920x1080 @ 15~30fps MJPEG/ 5fps YUV 1280x720@ 15~30fps MJPEG/ 10fps YUV 960x540; 848x480@15~30fps MJPEG/ 20fps YUV 640x480; 640x360; 424x240;320x240; 320x180; 176x144; 160x120@15~30fps MJPEG; 30fps YUV	Drawing	Model	Sensor type	Lens	LED	DOF	Interface
Resolution	USB 2.0			<a href="#">10-VD5x8-311-2W-77</a>	1/6" CMOS COLOR	77° lens	white LED x 6 (high intensity LED)	45-20-80mm	USB 2.0
	USB 3.0	<b>standard:</b> 1920 x 1080; 1280 x 720; 640 x 480 @60 fps MJPG/YUV <b>fixed:</b> 1920 x 1080 @60 fps MJPEG/YUV 1280 x 720 @90 fps MJPEG/YUV 640 x 480 @120 fps MJPEG/YUV 320 x 240 @ 240 fps MJPEG/YUV		<a href="#">10-VD8x8-311-2W-77Y</a>	1/6" CMOS COLOR	77° lens	IR 850nm LED x 6	infinity	USB 2.0
Camera head material	stainless steel			<a href="#">10-VD8M8-311-2W-77</a>	1/6" CMOS B/W	77° lens	IR 850nm LED x 6	infinity	USB 2.0
Probe length	2M			<a href="#">10-VD908-311-2W-77Y</a>	1/6" CMOS COLOR	77° lens	IR 940nm LED x 6	infinity	USB 2.0
Probe length material	outer braid and stainless steel			<a href="#">10-VD9M8-311-2W-77</a>	1/6" CMOS B/W	77° lens	IR 940nm LED x 6	infinity	USB 2.0
Articulations	2 way articulations			<a href="#">10-VD5x8-311-2W-88</a>	1/6" CMOS COLOR	88° lens	white LED x 6 (high intensity LED)	45-20-80mm	USB 2.0
Bending section length(mm)	42.7 mm			<a href="#">10-VD5x8-311-2W-93</a>	1/6" CMOS COLOR	93° lens	white LED x 6 (high intensity LED)	45-20-80mm	USB 2.0
Radius of gyration (at angle 90° )	21 mm			<a href="#">10-VD5x8-311-2W-158</a>	1/6" CMOS COLOR	158° lens	white LED x 8 (high intensity LED)	45-20-80mm	USB 2.0
UVC format	MJPEG / YUV			<a href="#">10-SVD5x8-311-2W-77</a>	1/6" CMOS COLOR	77° lens	white LED x 6 (high intensity LED)	45-20-80mm	USB 3.0
Image area	2.7288 x 1.5498mm			<a href="#">10-SVD8x8-311-2W-77Y</a>	1/6" CMOS COLOR	77° lens	IR 850nm LED x 6	infinity	USB 3.0
Sensitivity	553 mV/(Lux-sec)			<a href="#">10-SVD8M8-311-2W-77</a>	1/6" CMOS B/W	77° lens	IR 850nm LED x 6	infinity	USB 3.0
Dynamic range	73.3 dB @ 15.5x gain			<a href="#">10-SVD908-311-2W-77Y</a>	1/6" CMOS COLOR	77° lens	IR 940nm LED x 6	infinity	USB 3.0
Lens (specify when ordering)	77° lens	1.83mm/2.0/F5.0/8.0 (H= 69°; V= 43°; D= 77°)		<a href="#">10-SVD9M8-311-2W-77</a>	1/6" CMOS B/W	77° lens	IR 940nm LED x 6	infinity	USB 3.0
	88° lens	1.55mm/F5.7 (H=48.4°; V=78.3°; D=86.8°)		<a href="#">10-SVD5x8-311-2W-88</a>	1/6" CMOS COLOR	88° lens	white LED x 6 (high intensity LED)	45-20-80mm	USB 3.0
	93° lens	1.5mm/F5.7 (H=81°90';V=50°18';D=92°82')		<a href="#">10-SVD5x8-311-2W-93</a>	1/6" CMOS COLOR	93° lens	white LED x 6 (high intensity LED)	45-20-80mm	USB 3.0
	158° lens	1.523mm/F4.8/6.0/8.0 (H=132°; V=65°; D=158°)		<a href="#">10-SVD5x8-311-2W-158</a>	1/6" CMOS COLOR	158° lens	white LED x 8 (high intensity LED)	45-20-80mm	USB 3.0
LED dimmer	support								
Snapshot & Freeze Function	support								
Camera setting on smartphone	support								
Compatibility with wifi DVR	support								
Power source	DC 5V (USB) / 190mA								
Storage temperature	-30 to 60 Degree C								
Working temperature	-10 to 45 Degree C								
Operating system	Windows XP, windows Vista, window 7, windows 8, windows 10, Linux, MAC OSX								



## 2-way articulation videoscope camera

MISUMI has two types of 2-way borescopes.

2-way articulation probe bend angle up to 190(-10) degrees with 3D bend angle more than 360 degrees.

This flexible design, make it easy to inspect hard to reach areas.



more than 360°

Use the control wheel for changing the bending angle.



Model: 10-VD508-311-2W-77

Use the lever of the control bar for changing the bending angle.



Model: 10-VD518-311-2W-77



## Ø6 x 10mm Short Camera Head!

The camera diameter is 6mm and the length is 10.4mm.  
A short tube head can help you to inspect hard reachable places or angles.

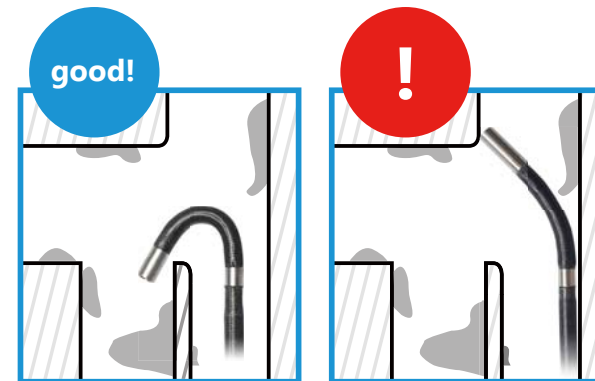

## Tighten / Loosen to Control Camera Head!

Turn the adjustable wheel to flexibly control camera articulation angle.  
Articulation angle can be tighten / loosen at any degree.





## High brightness LED & Dimmer

With 6 high-brightness LEDs, the camera can capture clear images in a completely dark environment.

Camera is equipped with dimmer function to control LED brightness for micro focal distance or long focal distance, to prevent exposure in micro focal distance.

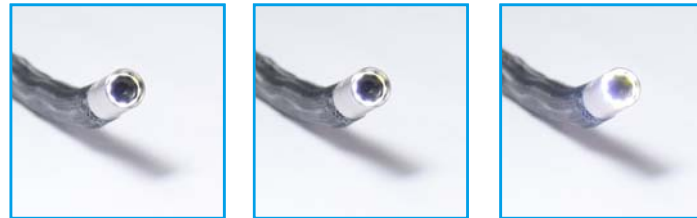

## 1080p Outstanding Quality & UVC signal output !

1080p Full HD resolution and UVC signal output.  
Compatible with PC, MAC and Android devices.





## UVC signal output !

The connector is available at USB A type, Micro USB OTG B type, USB type C or customized for specify when ordering.



Type C    Micro USB OTG    USB A



## Freeze frame Function

Freeze frame function is perfect during inspection or surgery to pause image and do analysis.



## Snapshot Function

Snapshot function is perfect for capturing and saving the photo during inspection

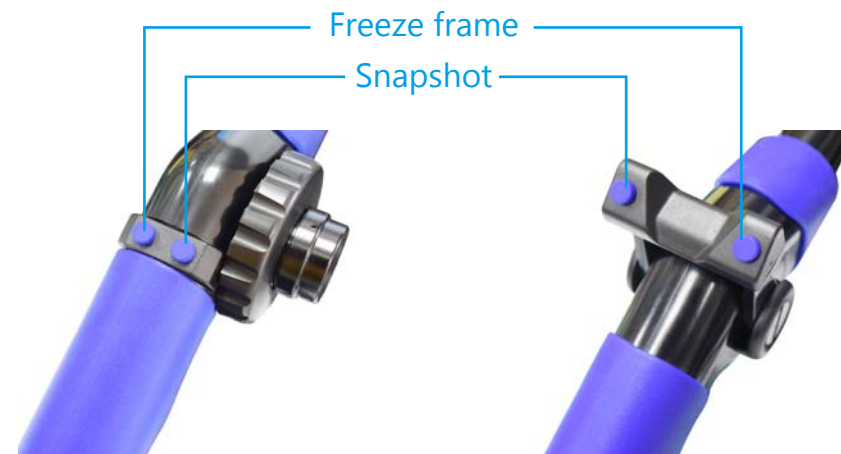



## Waterproof IP 67

Protected from total dust ingress.  
Protected from long term immersion and 1 meter in depth.

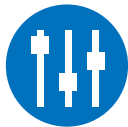

## Camera parameter adjustable

Camera parameter can be adjusted on the smartphone via the Misumi app and PC viewer software AMCAP.

- Brightness ✨
- Gain ✓
- Contrast ●
- Gamma γ
- White Balance 📷
- Exposure time ABS
- Sharpness ✨
- Backlight Compensation
- HUE 🎨
- Saturation 🌈
- Mirror 🔄
- Flip 📄
- Frame rate 30fps
- Resolution 1920x1080

